



The high performance long distance runners

Hammelmann high pressure pumps, units and components

High pressure pump range

High pressure units

Pump technology

High pressure application systems

Pumps for special applications

Hammelmann worldwide

The high performance long distance runners

Ten thousands of Hammelmann high pressure pumps are operating worldwide and in almost all branches of industry. Whether running around the clock or just intermittently what counts for our customers are energy efficiency, reliability, performance, service and innovative solutions. We see these challenges as our daily obligation.

Contents

High pressure pump range

HDP 20 V • HDP 30 • HDP 40	5
HDP 70 • HDP 70 V • HDP 80	
HDP 140 • HDP 200 • HDP 300	7
HDP 400 • HDP 500 • HDP 800 • HDP MC	9

High pressure pump technology

Valve housing and valve technology, suction chamber	11
Sealing systems, oil seal bellows system, crank section	13
Conversion kits, maintenance and service, training	15
Quality	17
Controls	19
Telematics	21

High Pressure pumps for special applications

Industrial cleaning	22
Corrosion protection	24
Concrete rehabilitation	25
Automotive industry	26
Cutting systems	27
Use of hot water	28
Underwater applications	29
Process pumps	30
Sewer cleaning pumps	32
Mining pumps	33
Pressure and pulse testing	34

High pressure units

Diesel units	36
Electric units	38

High pressure application systems

Hammelmann worldwide

Catalogues

High pressure pumps and units
High pressure application systems
Efficient corrosion protection
Process plunger pumps

Online

hammelmann.com/hdp
hammelmann.com/catalogue
hammelmann.com/ship
hammelmann.com/process

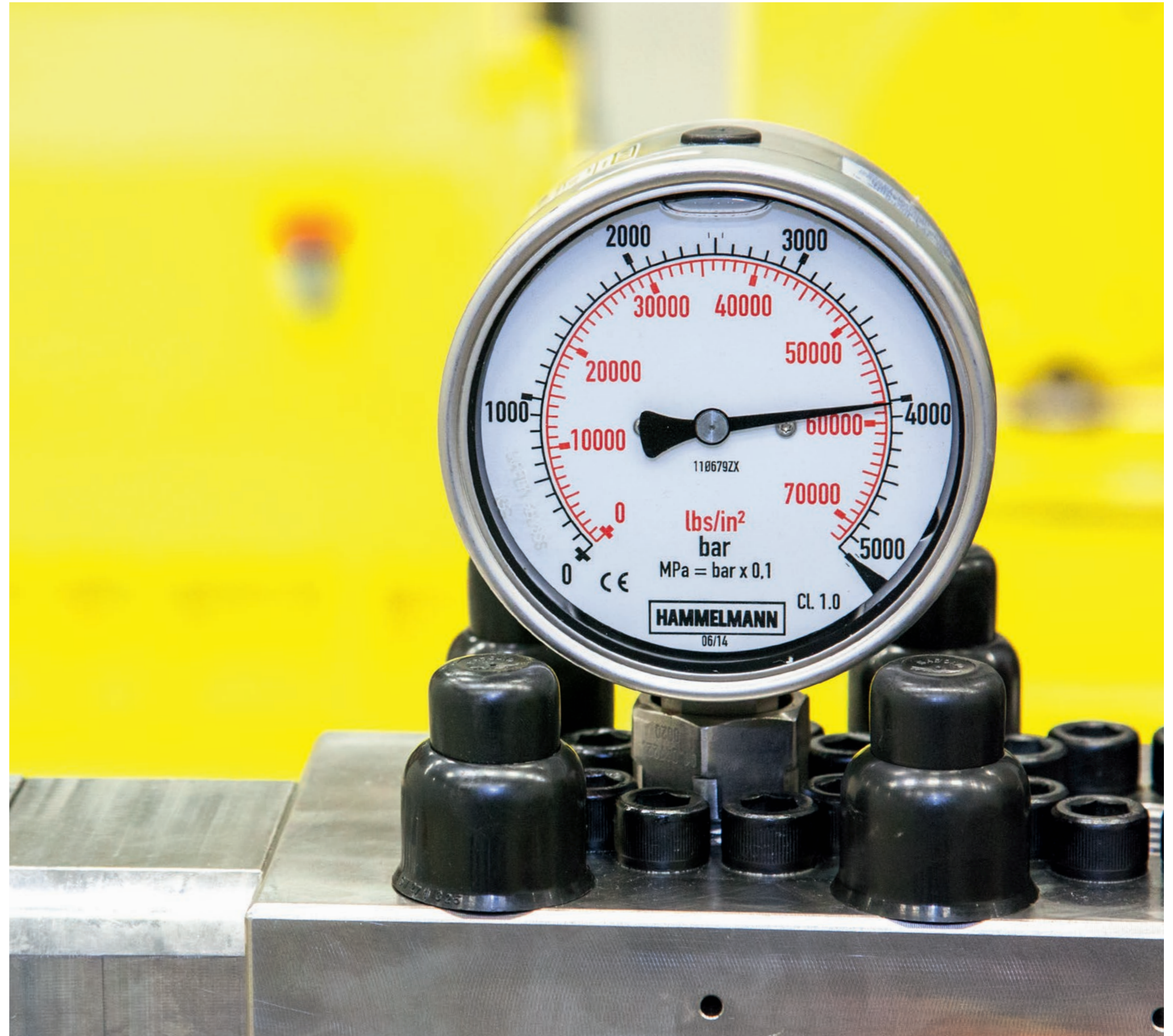

Hammelmann high pressure pumps with operating pressures up to 4000 bar are in use in many fields of industry.



Test stations for all pump models, collation, evaluation and documentation of all relevant operating data.

High pressure pump range



HDP 20 V
 High pressure pump with variable stroke
 up to 3300 bar
 0 – 111 l/min
 up to 18,5 kW
 3 Cylinders
 205 kg
 788 x 323 x 707 mm



HDP 30
 up to 3800 bar
 2,2 – 103 l/min
 up to 30 kW
 3 Cylinders
 190 kg
 523 x 303 x 780 mm



HDP 40
 up to 3800 bar
 5,5 – 155 l/min
 up to 45 kW
 3 Cylinders
 200 kg
 523 x 303 x 779 mm



HDP 70
 up to 3800 bar
 7,2 – 246 l/min
 up to 75 kW
 3 Cylinders
 215 kg
 495 x 303 x 813 mm



HDP 70 V
 up to 3800 bar
 7,2 – 246 l/min
 up to 75 kW
 3 Cylinders
 263 kg
 850 x 303 x 813 mm



HDP 80
 for Aquajet 08 unit
 up to 2500 bar
 17,4 l/min
 up to 80 kW
 3 Cylinders
 215 kg
 495 x 303 x 813 mm



High pressure pumps in the aluminium industry. Above in operation since 2009 with an average of 5000 operating hours per year.

High pressure pump range



HDP 140

up to 4000 bar 3 Cylinders
 13 – 343 l/min 380 kg
 up to 140 kW 586 x 394 x 1031 mm



HDP 200

up to 4000 bar 3 Cylinders
 20 – 489 l/min 525 kg
 up to 200 kW 674 x 474 x 1091 mm



HDP 300

up to 3200 bar 5 Cylinders
 33 – 1069 l/min 1070 kg
 up to 300 kW 968 x 480 x 1120 mm

HDP 20V	18,5 kW	
HDP 30	30 kW	
HDP 40	45 kW	
HDP 70	75 kW	
HDP 140	140 kW	
HDP 200	200 kW	
HDP 300	300 kW	
HDP 400	400 kW	
HDP 500	500 kW	
HDP 800	800 kW	
HDP MC	1100 kW	

For every task the matching pump performance.



High pressure pump range



HDP 400

up to 3000 bar 3 Cylinders
 45 – 1289 l/min 1700 kg
 up to 400 kW 914 x 634 x 1449 mm



HDP 500

up to 3000 bar 3 Cylinders
 52 – 1280 l/min 1960 kg
 up to 500 kW 1053 x 630 x 1568 mm



HDP 800

up to 3000 bar 5 Cylinders
 87 – 2133 l/min 3700 kg
 up to 800 kW 1390 x 760 x 1592 mm



HDP MC

up to 3000 bar 7 Cylinders
 126 – 2987 l/min 5361 kg
 up to 1100 kW 1764 x 874 x 1699 mm

The pump design for reliability

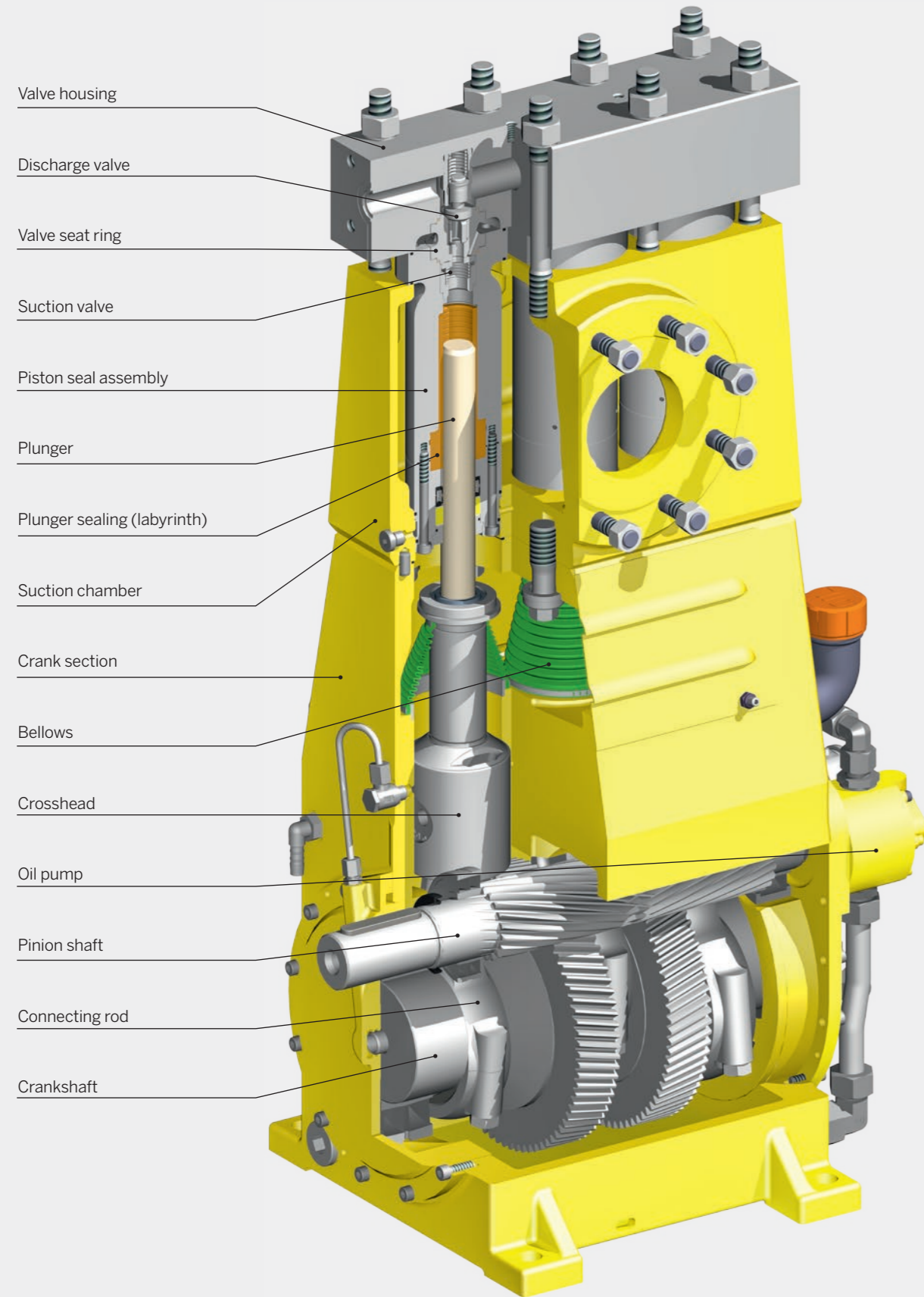

High pressure pump technology

Valve housing

The valves are housed in the pump head. The stress reversal free valve housing delivers the water flow to a central discharge connection.

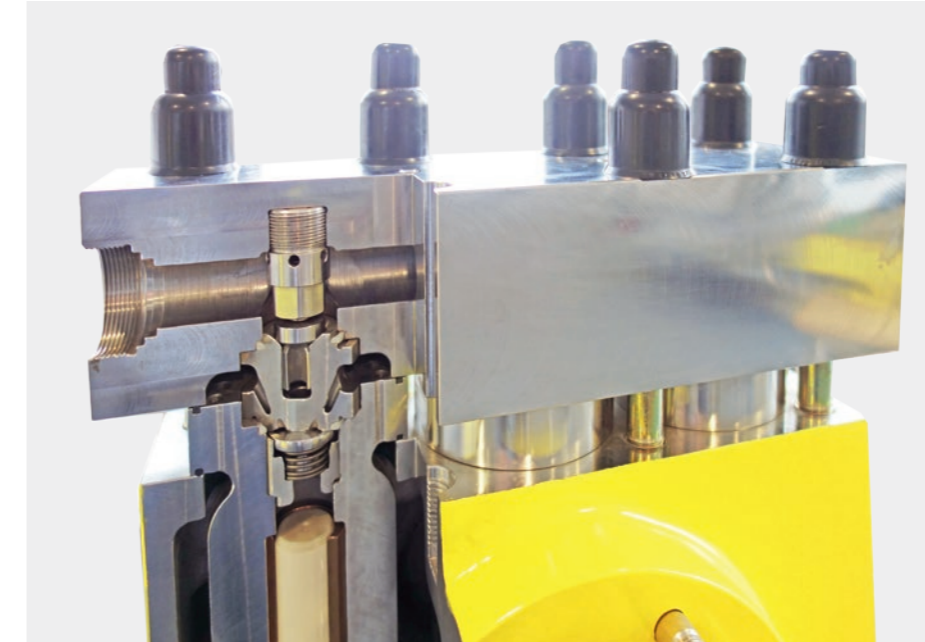

Standardized connection systems allow adaptations of a variety of regulating and safety devices. Customer specific special-purpose solutions are also easily implemented.

Suction chamber

The medium is fed to the pump via a central inlet in the suction chamber. The dynamic components of the sealing system are located inside the suction chamber. This closed system provides an optimal fluid feed to the high pressure pump and additionally increases safety.

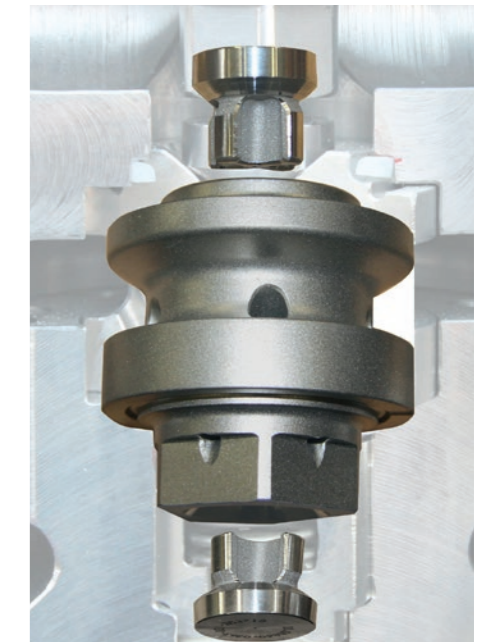
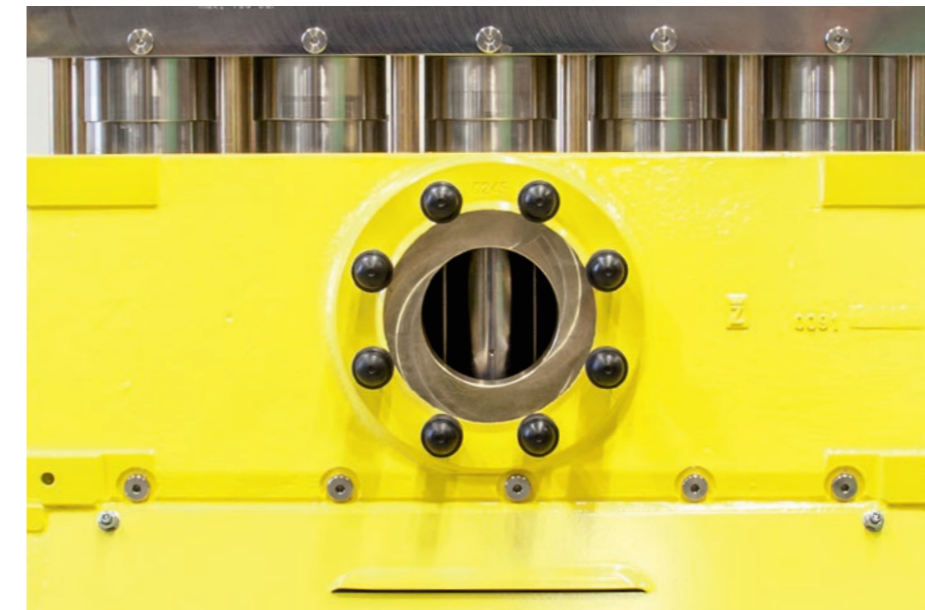

Valve technology

Suction and discharge valves are arranged coaxially. The compact design ensures a considerably higher efficiency than conventional high pressure pumps.



High pressure pump technology

High pressure seals

The various plunger seal systems employed by Hammelmann enable safe and reliable, continuous duty at operating pressures up to 4000 bar.

The choice of seal system used is dependant upon the pump application.



Bellows system

The bellows sealing system hermetically separates the fluid end from the power end thus preventing the ingress of liquids or gases.

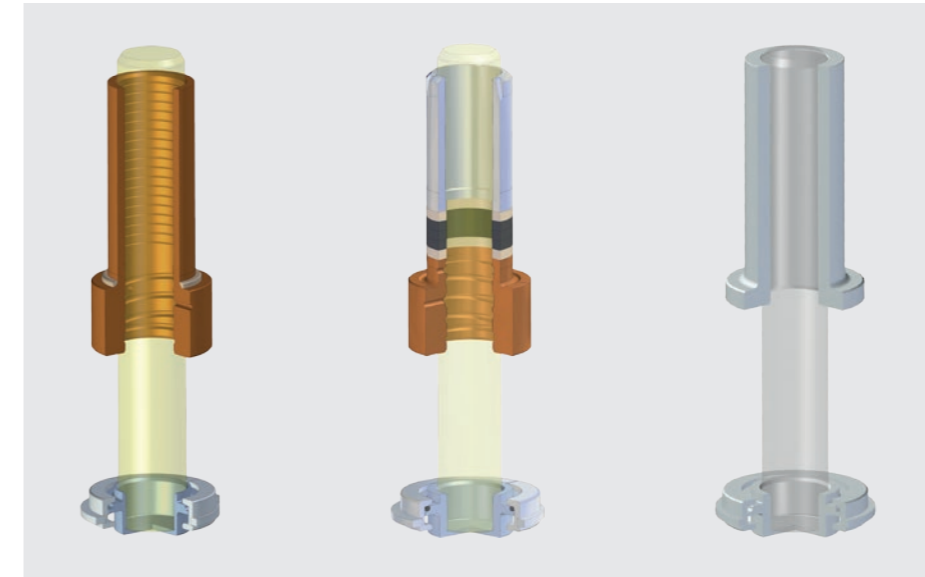

Labyrinth sealing up to 2000 bar

The friction free sealing comprises a labyrinth seal and ceramic plunger system. The labyrinth sealing design stands out for its operational reliability and that the service intervals can be planned.

Packing seals up to 3000 bar

Packing rings are used for this high pressure seal arrangement. The ceramic plunger is guided by a separate bushing. Packing seals can be used for various media.

Dynamic plunger sealing up to 4000 bar

The dynamic plunger sealing system is used mainly for ultra high operating pressures. The design and material composition of this sealing system results in high efficiency, an extreme wear resistance and high reliability.

Crank section

The integral reduction gear with double helical gears ensures smooth running and even power distribution. The various gear ratios allow the optimal selection to suit the customers' requirements.

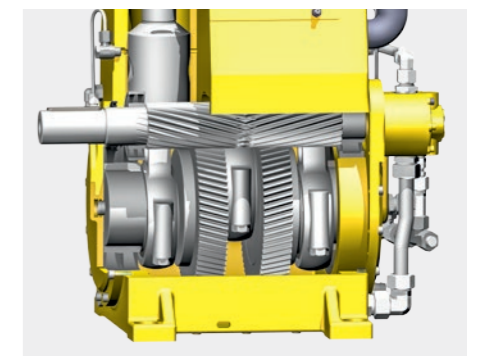

The compact design eliminates the need for an external gear box or an oversized flywheel. The mechanical efficiency of the continuous duty crank section is in excess of 95 %.



High pressure pump technology

Compact vertical design

The vertical pump design has many advantages: minimum space required due to very small footprint, neutral weight loading is gentle on the components, the beneficial flow pattern of the medium and the low stress to the base frame avoiding unwanted lateral oscillations.

Conversion kits

All Hammelmann pumps can be converted to other operational performances (flow rate and operating pressure).

If there is a regular need to change the performance, the required pump head and plunger seal sets can be pre-assembled as a compact unit for a quick change. This increases the reliability of the conversion and greatly reduces the time required.

Training

Training by experts is particularly important for your operatives. Hands on, practice-oriented training enables participants to retain the knowledge gained.

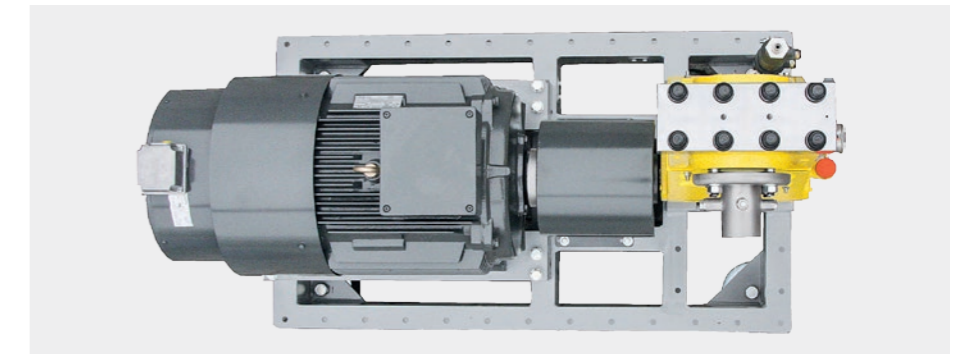

Maintenance

Hammelmann high pressure pumps are very maintenance friendly. An examination of all wearing parts can be carried out with standard tools in easy steps. The well planned construction of the high pressure pump and the clearly arranged components simplify the assembly.



The vertical configuration of the Hammelmann pumps allows maintenance at typical working heights.

Service

The acknowledged Hammelmann Service is based on a close-knit worldwide service network, readily available spare parts and short reaction times.

Customer requirements have foremost priority whereby questions can often be solved by telephone. For this we offer a **24-hour service hotline**. Our specialists are glad to help you either with instant fault analysis, give you trouble shooting tips to point you in the right direction, or directly process spare parts orders.

Service hotline: +49 (0)171 4707265



Hammelmann high pressure pumps are designed for long-life operation. Maintenance intervals depend on the individual local conditions, e.g. continuous duty operation, performance parameters and circumstances on site. Flexible, competent and experienced employees are available for all maintenance and repair work.

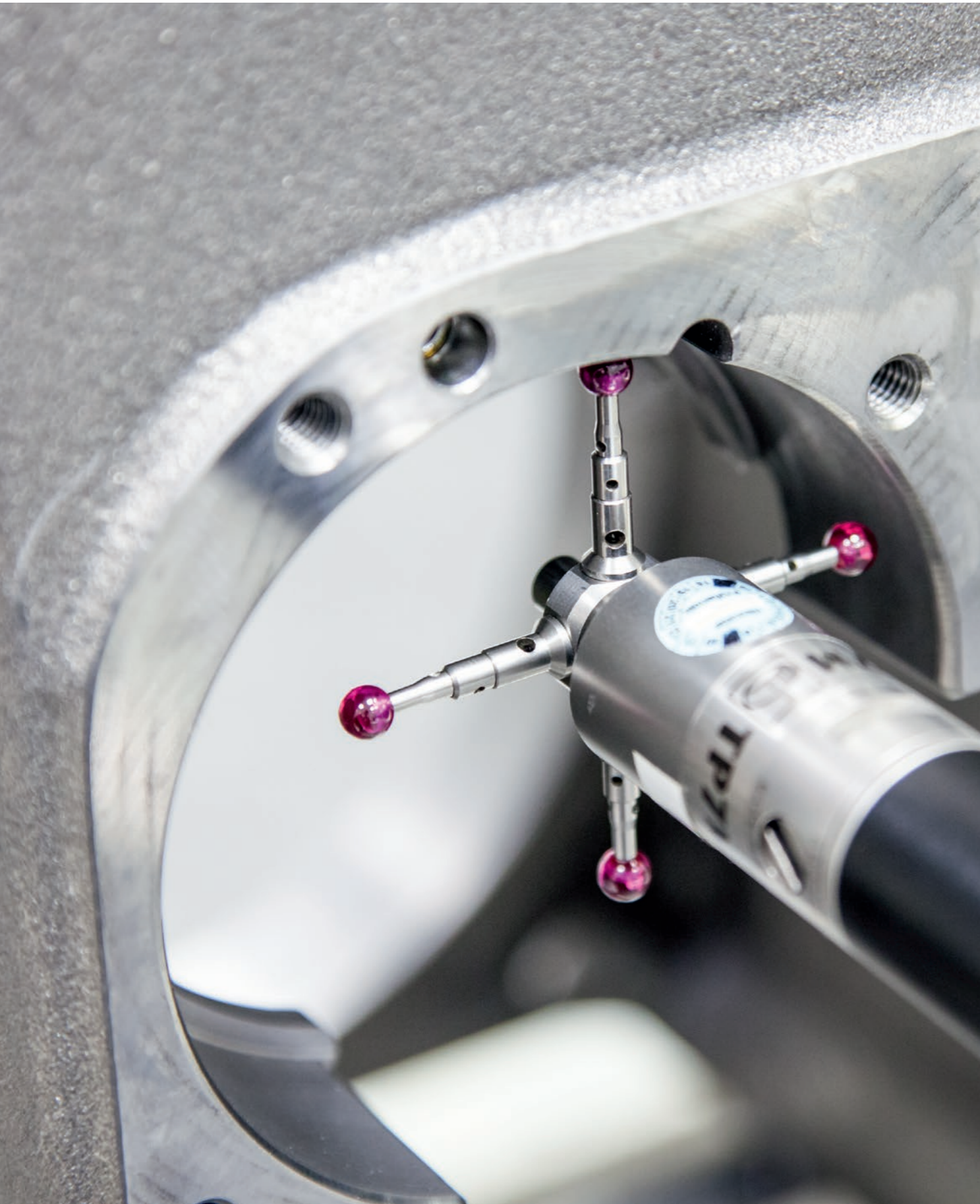

Quality

Development technology

The most modern design and simulation technologies provide for the optimal design of components.

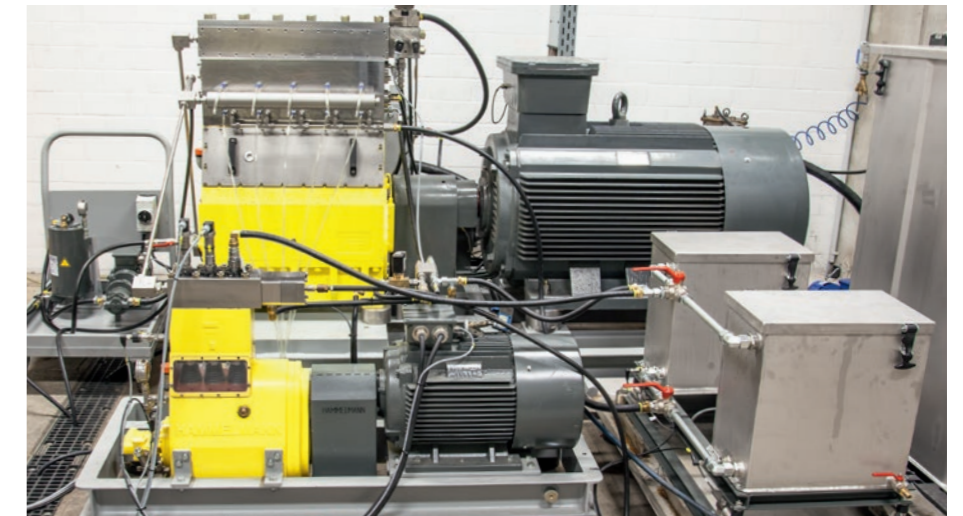
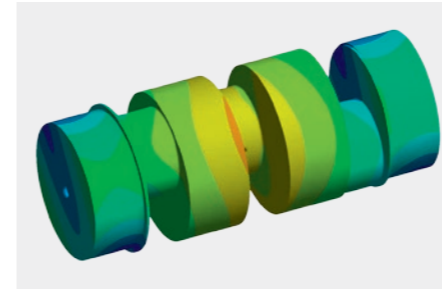

During new development work comprehensive stress and long term fatigue testing is carried out under true operating conditions. The resultant data is analyzed and optimizations implemented as required.

Materials

All materials and bought-in parts are subjected to the strict control of our quality management system. The high quality materials come from reliable sources. The material and processing quality are checked and documented.

Hammelmann has extensive experience in the selection and processing of special materials.

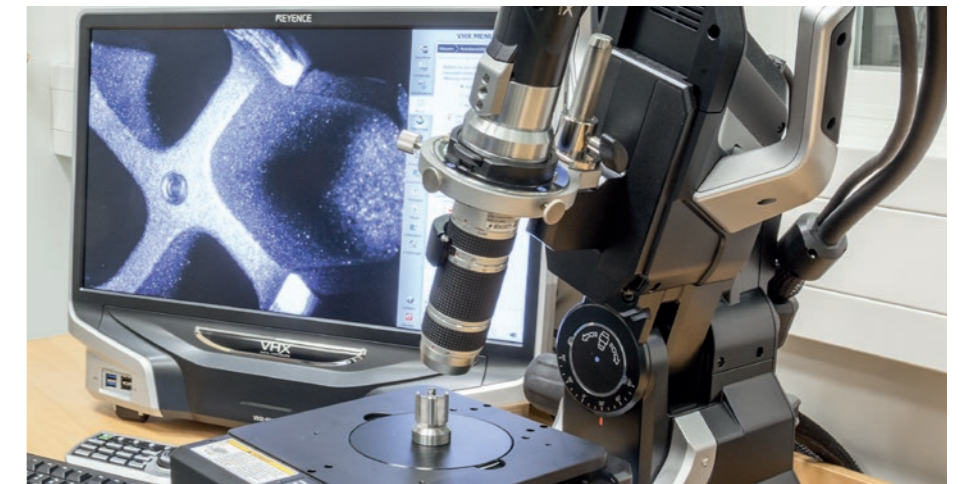

Quality control

Hammelmann products and supplies are subject to the strictest quality control. For this purpose, we have the latest measurement methods available.

Hammelmann relies on a continuous data flow from design to the machine programming, to the tool selection and to the processing machines.

Acceptance test

All high pressure pumps are subjected to an extensive final quality assurance test in our modern test centre prior to delivery.

The test results are part of the machine documentation. On request special acceptance tests can additionally be carried out by external inspectors.





Controls

ES3 Controls

- Intuitive remote control
- Clear display of all operating conditions
- Selectability of various operating modes
- Colour display with touch screen
- International character sets allow all languages to be shown
- Updates possible via USB
- Central monitoring and storage of motor and pump data
- The ES3 control can be supplemented by additional safety monitors
- Ready to accept Ethernet interface
- Direct pre-selection of the gear ratios possible with integral electric intermediate gear boxes
- The ES3ioBox offers additional freely definable inputs for the evaluation of further data and for communication with other controllers
- The ES3 display installed in various positions on the high pressure system
- Robust industrial model
- High computing capacity

Basic functions

Operation

Controller On/Off
 Engine Start/Stop
 Preheat On
 Set value +/-
 High pressure On/Off
 Additional functions

Regulating

Engine speed regulation
 Engine speed control
 Pressure regulation
 Variable regulation
 Customer specified regulation

Monitoring

Engine oil pressure
 Engine temperature
 Pump oil pressure
 Boost water pressure
 Water filter
 High pressure
 Additional functions



JetControl controller (PLC)

Controls and monitors constant speed, electrically powered pump units (star delta or soft start).

- Pump monitoring with analogue sensors
- Information menu with actual unit status (bar/°C)
- Fault announcements in clear text
- Special projects and control tasks are also viable with the JetControl PLC, for example, high pressure pumps for cutting systems, high pressure pumps with variable stroke, servomotor controls, etc.





Telematics

Hammelmann telematics enables permanent access to the operating parameter data of one or more high pressure pump unit(s) in the field wherever the location.

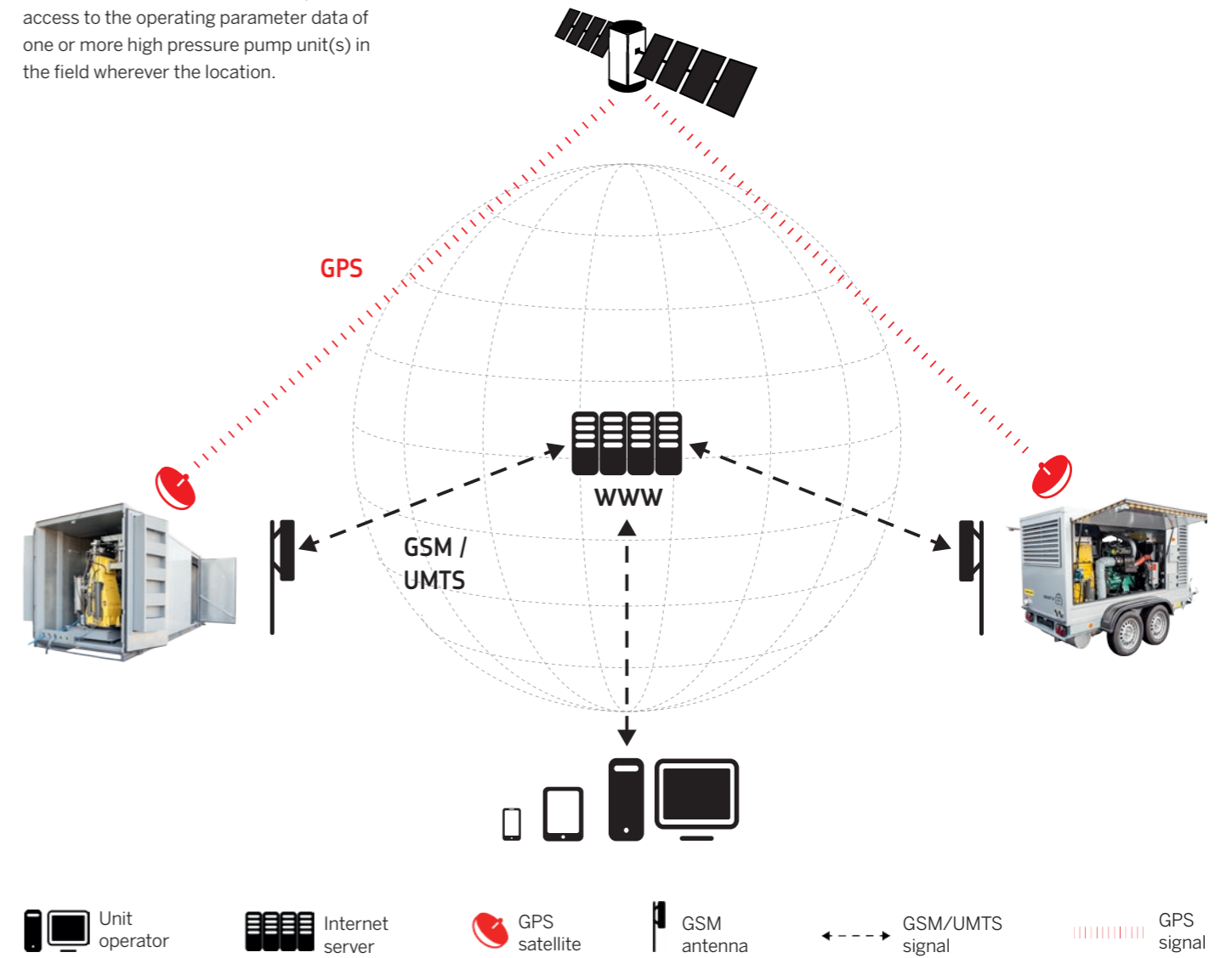

Locating

The telematics modules receive positional data from the GPS*. These are transmitted at regular intervals to a server in the World Wide Web and saved. The pump owner/operator can constantly track the position(s) of the unit(s).

Operational data transmittal

The operational data is permanently transmitted by GPRS* via local radio masts to a server in the World Wide Web and saved.

Operational data display

The data on the server is displayed over an internet site accessed by user name and password. The following data is available over the web page

- High pressure
- Engine RPM
- Unit operating hours
- Pump operating hours
- Fuel tank content
- Fuel consumption
- Other values if required
- Fault memory

Hammelmann Service

If requested Hammelmann can make a live connection to the pump unit ES2 / ES3 controls via the server enabling the following servicing functions:

- Operational data diagnosis
- Fault protocol read out
- Set/adjust operating parameters
- Remote maintenance

* GPS = Global Positioning System

* GPRS = General Packet Radio Service

High pressure pumps for industrial cleaning

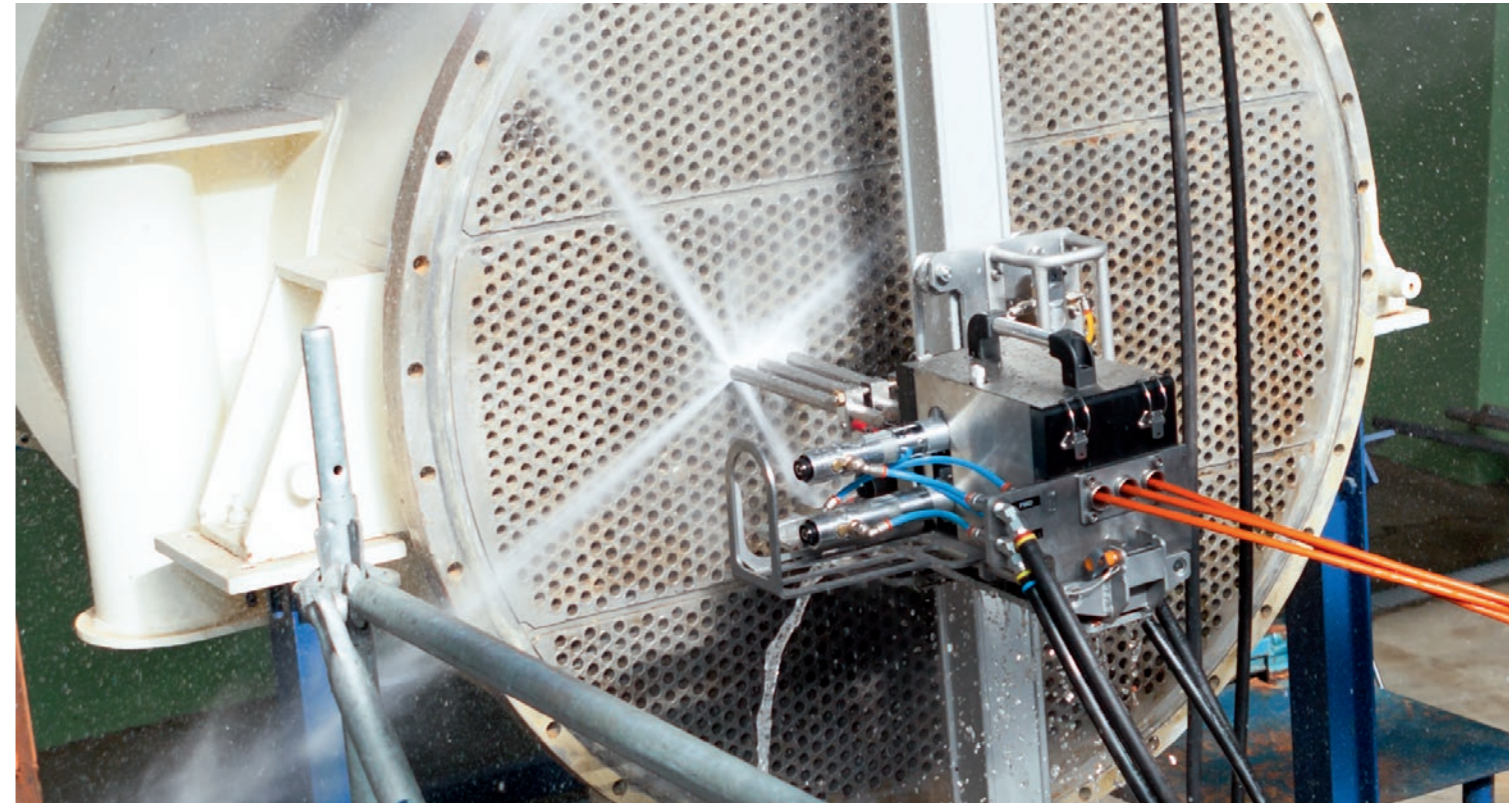

High pressure pumps in every design size for manual and automated industrial cleaning.

Examples for the use of high pressure water for industrial cleaning:

- Cleaning heat exchangers, condensers, coolers, valves
- Cleaning vessels, reactors, autoclaves, tanks
- Cleaning production and transportation equipment, machine parks, storage areas, contaminated flooring, furnaces
- Cleaning machinery, structural steelwork
- Decontamination, disinfection
- Cleaning scaffolding, shuttering machinery etc.



Electric motor powered high pressure pumps in every design size with frequency inverters and other system components



Sound damping canopies for stationary and mobile high pressure units



Units with manual gear box

High pressure pumps for corrosion protection



From bridge railings to supertanker the Hammelmann range includes the right high pressure pumps for all manner of preparation work for corrosion protection.

Use of high pressure water for

- Paint removal
- De-coating
- De-rusting

Online catalogue: hammelmann.com/ship



Modern diesel engines meet the requirements of local exhaust gas legislation.

High pressure pumps for concrete rehabilitation



Hammelmann high pressure units offer a wide performance range, for hand-lancing operation and up to heavy concrete removal with robots.

- Selective removal of surfaces, e.g. spalled concrete, plaster, rendering, asphalt
- Cutting doorways, access ways in tunnels and concrete structures
- Roughening and preparing concrete and stone surfaces
- Reinforcing bar exposure
- Cleaning natural stone walling
- Expansion joint removal
- Laitance removal
- Cold cutting metal structures



Sound damping canopies for stationary and mobile high pressure units



Super-Silent Container, with greatly reduced sound development due to special speed-reduced motors and super-sound insulation

High pressure pumps for the automotive industry

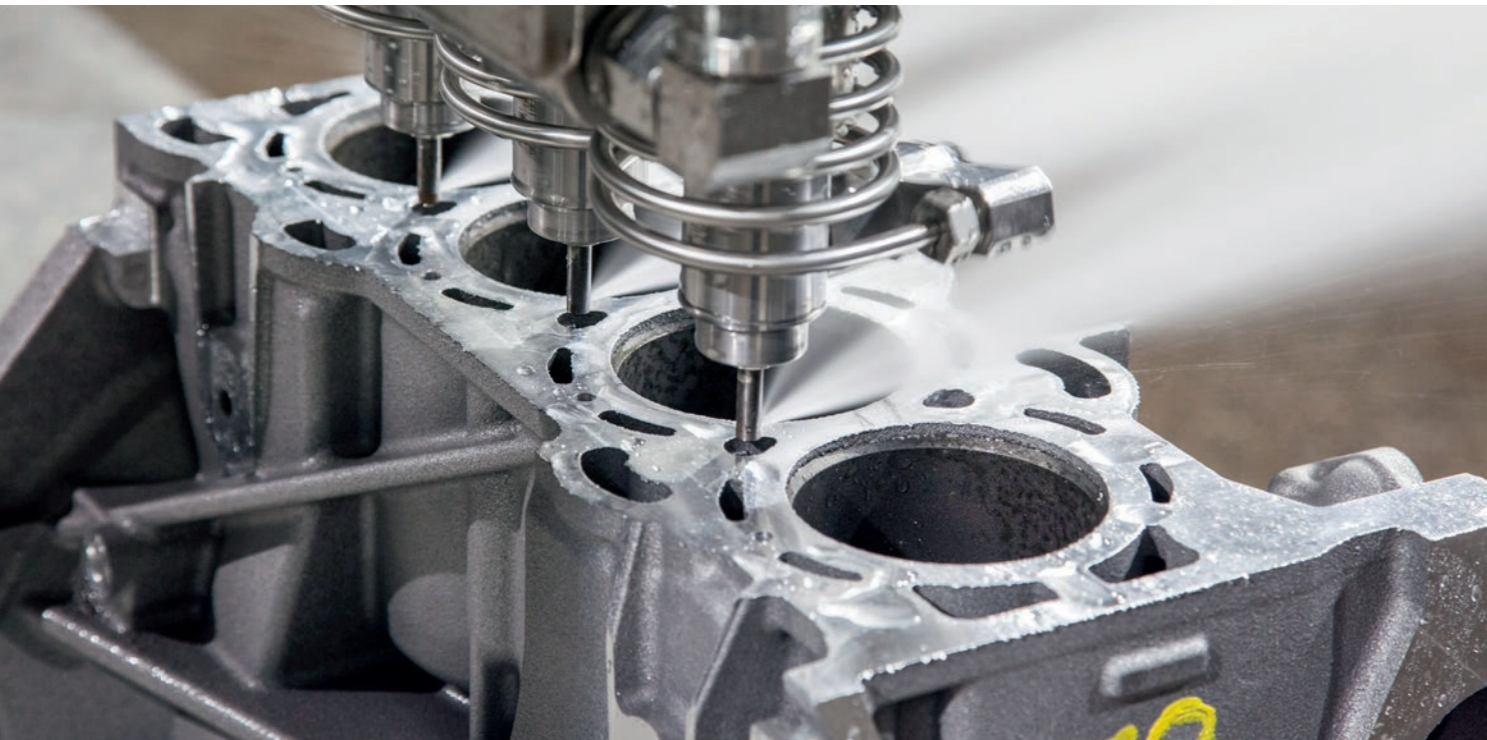

Compact high pressure units in various sizes for use in the automotive industry, for example for engine component deburring, swarf removal and roughening of cylinder surfaces.

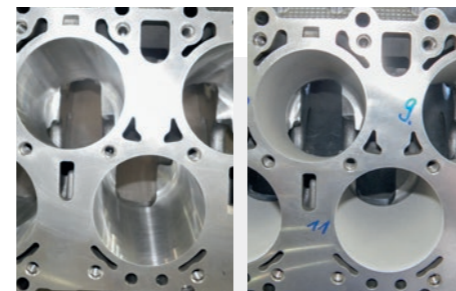
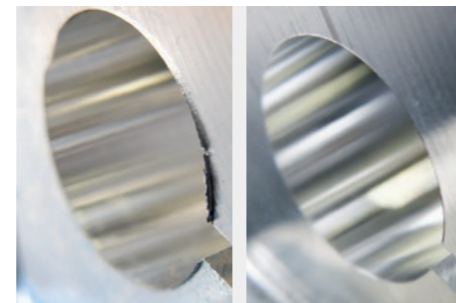

High pressure plunger pumps for cutting applications



Hammelmann pumps make especially economic use of the energy utilized. Intelligent design, the use of high strength materials and precise manufacturing of components ensure long service life at pressures up to 4000 bar.

The Hammelmann pumps for cutting applications can be combined with any cutting table.

With Hammelmann high pressure equipment it is possible to use only the exact motor power necessary for the actual cutting task in progress. This results in significant energy savings.

The high pressure pump together with its direct drive allows an increase in efficiency of up to 30 percent compared to pressure intensifier systems.

HDP Type	max. bar	max. l/min	kW
34	3800	4,3	15 22 30
44	3800	6,4	37 45
74	3800	10,4	55 75
144	3800	14	110
204	3800	18	132



High pressure pumps for hot water applications

75 80 90 95 100 110



The fluid end components of the Hammelmann high pressure pumps have been designed specially for hot water operation by selecting heat-resistant materials and sealing systems.

The high water temperatures allow, for example, the cleaning of tanks, heat exchangers and other surfaces contaminated with oils, greases, bitumen and resins. The fields of application are predominantly in the oil and gas and chemical industries.



Up to **95° C** high pressure pump models
HDP 400, 500, 800

Up to **110° C** high pressure pump models
HDP 40, 70, 140, 200, 300



A separate water heating unit supplies hot water at boost pressure. High pressure is generated by the high pressure pump.

High pressure pumps for underwater applications

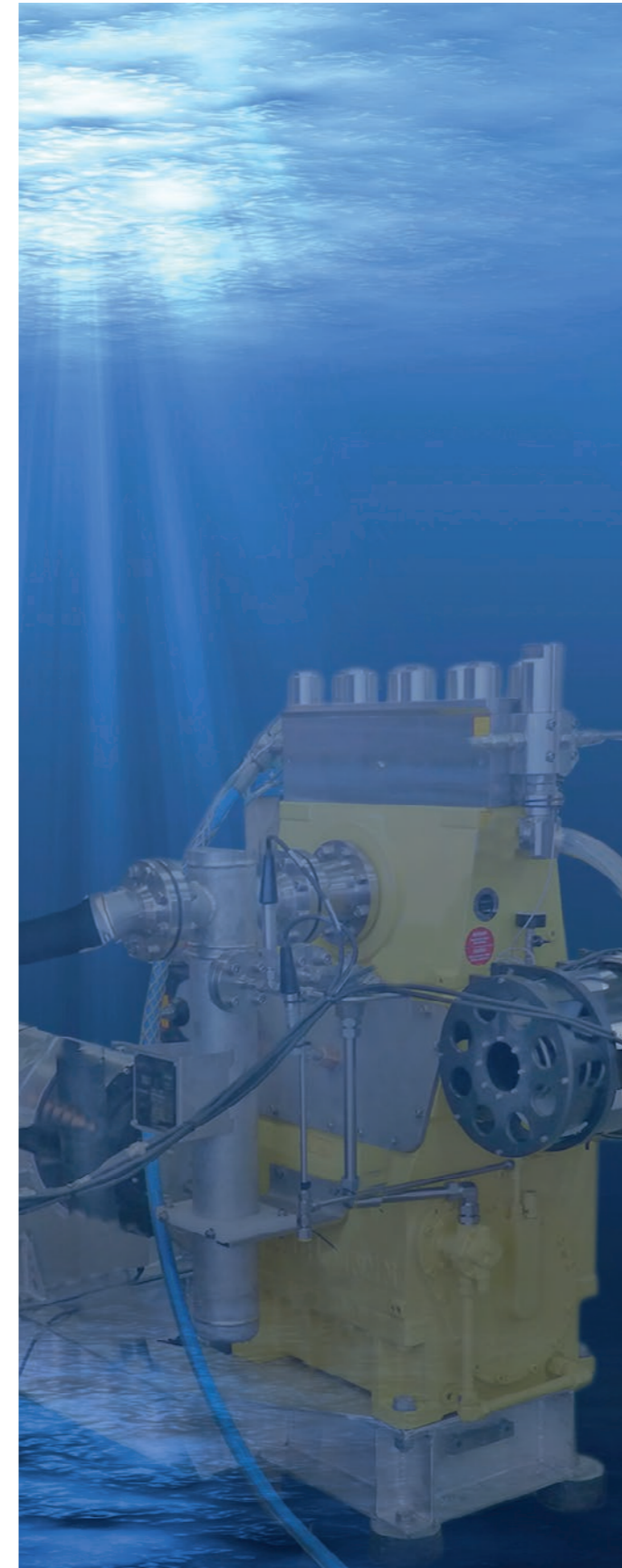

Onshore technologies are also increasingly being used subsea.

Application examples:

- Pipeline inspection and cleaning work
- Demolishing concrete foundations
- High pressure cutting
- Water-assisted dredging
- Coating removal

Hammelmann high pressure pumps are advancing this forward-looking trend and have already proven their worth under the water surface. The seawater can be used as the pumped medium.

The basis for reliable functioning is specially selected and approved materials. The pressure control valves are actuated hydraulically. The pumps are driven by an electric underwater motor. With the hermetically sealed intermediate chamber Hammelmann high pressure pumps offer a "clean" technology.

For subsea applications at great depths of up to 3000 m special solutions are offered. All Hammelmann pump models are convertible for underwater applications.

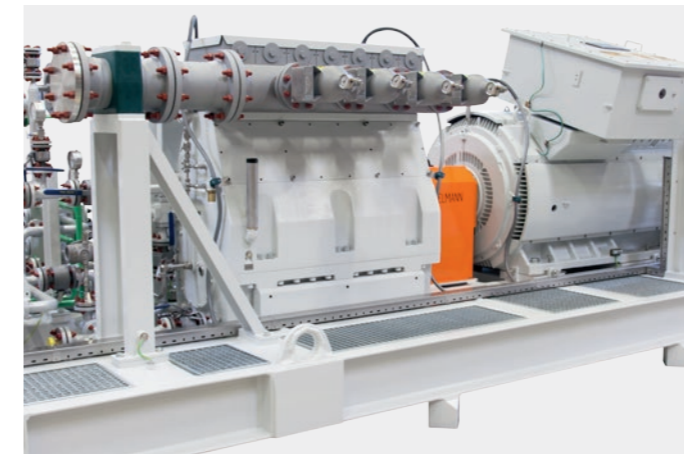

Pumps in the HAMPRO series satisfy the highest demands of safety and reliability. A wide range of suitable materials and designs are available for pumping diverse media.

Oil & Gas Industry

Media pumped / Process:

- Condensates
- Diesel
- Glycol
- Hot water
- Inhibitors
- Methanol
- Produced water
- Hydraulic fluids
- Scale squeeze
- Sea water
- Flowline service
- Leak tests

Chemical Industry

Media pumped:

- Methyl ester
- Meth acrylic acid
- Waste water
- Solvents
- Boiler feed water
- Liquid ammonia
- Carbon dioxide

Steel Industry

- Mill scale removal
- High pressure bearing lubrication

HAMPRO Series performance data

Type	max. bar	max. m ³ /h	kW
10	2200	6,2	11
20	3800	6,2	18,5
20 V	3270	6,7	18,5
40	3800	9,3	37
70	3800	14,7	70
70 V	3000	14,7	70
140	3800	20,5	140
200	3800	29,3	200
300	3200	64	300
400	3000	77	400
500	3000	77	500
800	3000	128	800
MC	3000	180	1100

Fluid temperatures: -40 bis +200 °C

Viscosities: up to 2000 mPa s

Sewer cleaning pumps



High pressure pumps with high flow rates suitable for use in recycling systems. The plungers are made of ceramic. A hermetic piston rod seal using bellows prevents oil leakage.

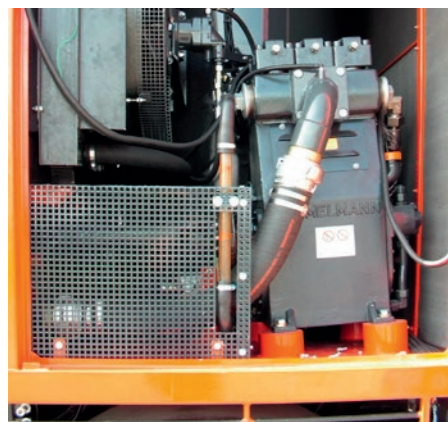

HDP 146

Op. pressure 160 – 230 bar
Flow rate 270 – 462 l/min
Power rating max. 135 kW
Sealing system Packing
Design horizontal, vertical



HDP 196

Op. pressure 160 – 210 bar
Flow rate 386 – 605 l/min
Power rating max. 180 kW
Sealing system Packing
Design horizontal, vertical

Mining pumps



Special Hammelmann high pressure pump units for use underground have a base frame with high torsional rigidity. The filters and control elements have firedamp protection. The valve technology is designed for use in mining applications.



Application examples:

- Underground high pressure stations for controlling the roof supports in longwall mining
- Spray systems for dust suppression

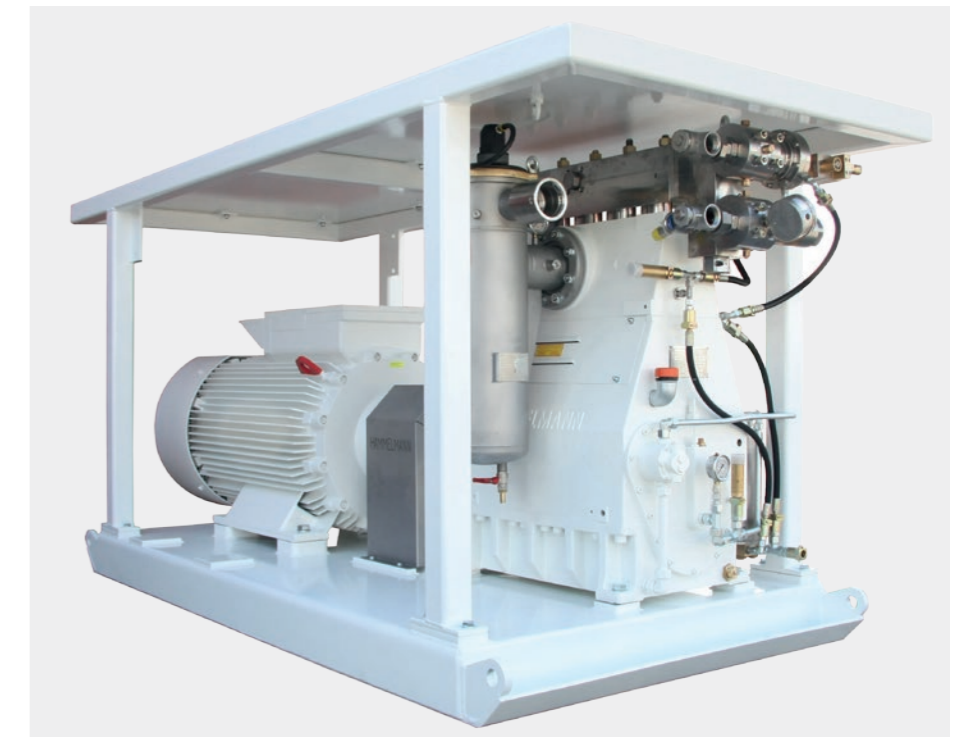

Example pressure station
Op. pressure 340 bar
Flow rate 400 l/min
Power rating 250 kW

Viscosities: 0,5 bis 100 cSt
Fluid temperatures: 0 bis 70° C
Media: water, emulsion, HFA
(High water fluid additive)

High pressure pumps for pressure and impulse testing

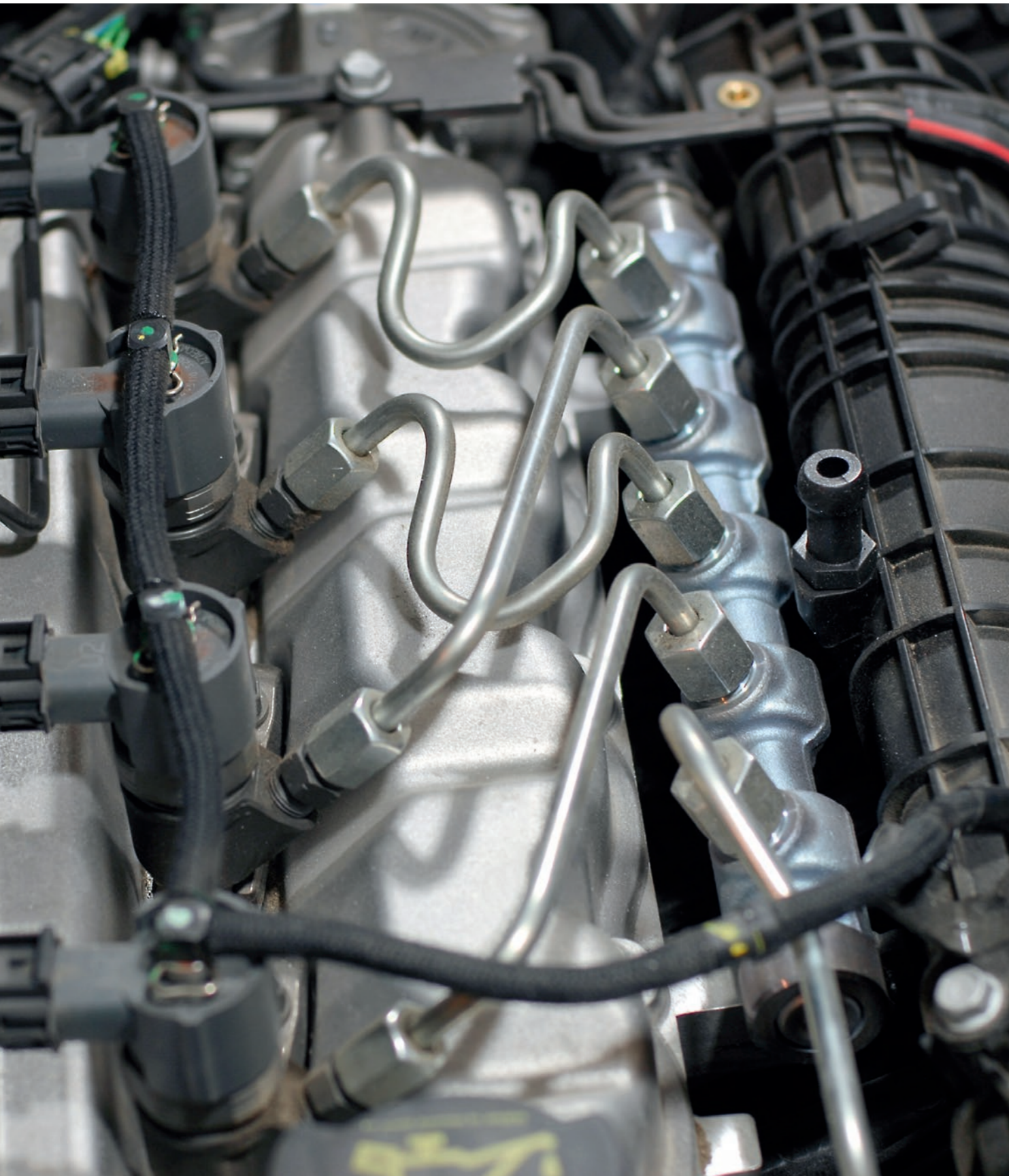

Pressure testing of boilers

State-of-the-art system solutions using high pressure pumps with appropriate valve and control technology enable pressure and impulse tests for a wide range of applications.

Hammelmann offers special solutions according to individual work definition. Together with the measurement data logging and documentation we create complete testing systems.

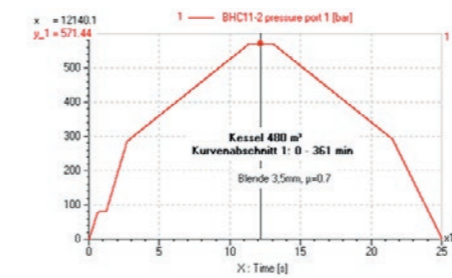

Impulse testing

For the strength testing of components Hammelmann offers variable stroke high pressure pumps in energy efficient design.

With the stroke adjustment, the pulsator can be precisely adjusted to the test pressure. The test frequency is adjustable between 2.5 and 20 Hz. The pulsator features an extremely low energy consumption at all test frequencies.

Application examples:

- Pressure fatigue tests
- Dynamic testing
- Determination of component strength
- Determination of material characteristics
- Internal pressure tests
- Dynamic leakage tests
- Component strength analysis
- Fatigue testing of common-rail components

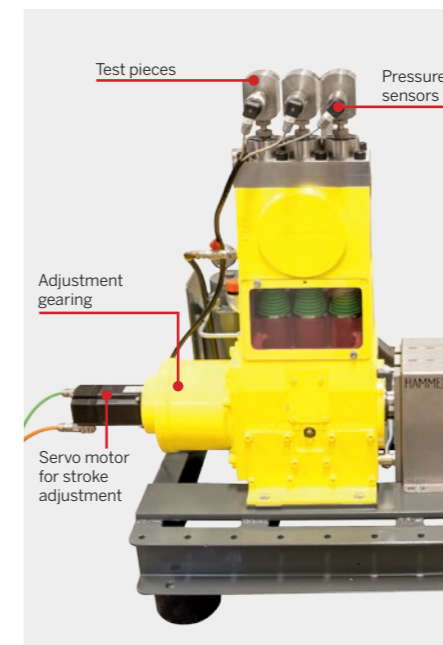

Speed [l/min]	Test frequency [Hz]	Test pressure [bar]	Power rating [kW]
300	5		0,8
600	10	1000	2,0
1200	20		5,8
300	5		0,6
600	10	2000	1,6
1200	20		4,7
300	5		0,9
600	10	2900	2,2
1200	20		6,2

Diesel units

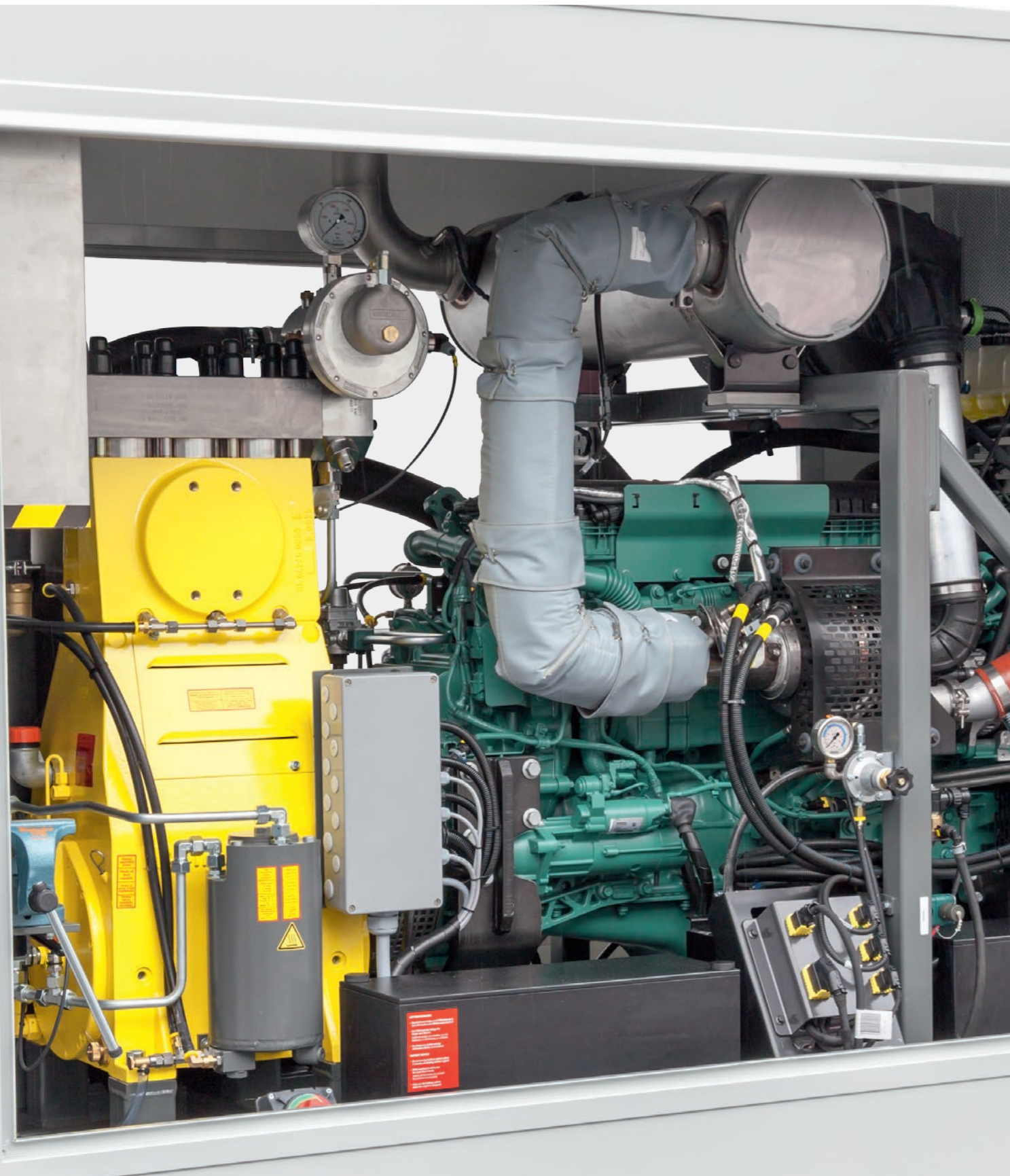

Stationary units



Road trailer, sound damped units



Stationary unit with exhaust treatment system

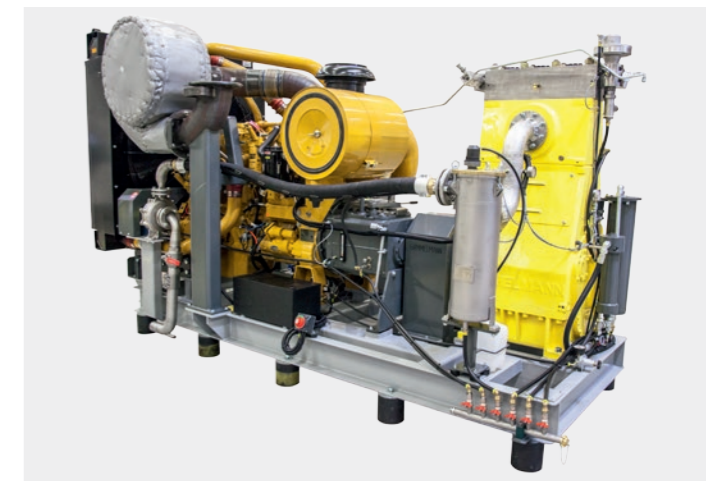

Unit with gear box



Installations in 10, 20 or 25 foot containers

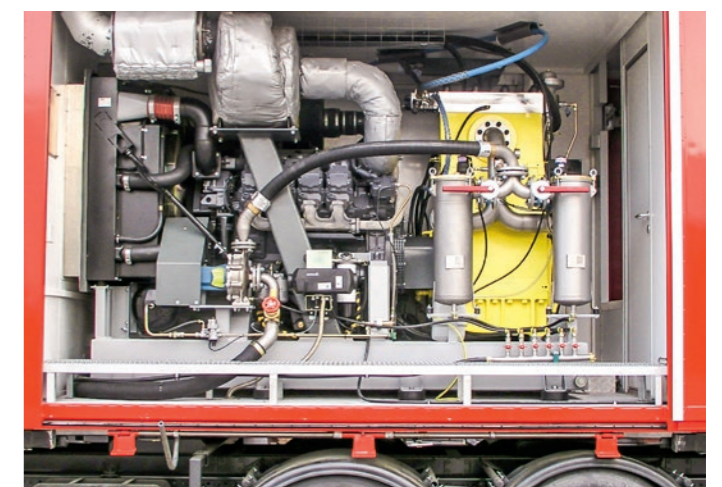

Special and truck installations

Electric units



Extra narrow units for on-board applications



3-module unit for transporting in elevators



Compact units with control panel and jetting tools



Mobile units with control panel



Stationary units



Installation in various container layouts



Aquamat - Tank cleaning units



Aquarex - Tank cleaning devices



Nozzles for heat exchanger cleaning



High pressure spray guns



Rotor jets



Jetmate - reaction force free jetting tool



Nozzles for pipe cleaning



Guide skirts for rotor jets



Custom-made cleaning devices



Jetboy - mechanical support for manual work



Dockmate - ship cleaning system



Aquablast Spot - to clean specific small areas



Aquablast - manual surface cleaning equipment



Spiderjet M - magnetically adhering surface cleaning device

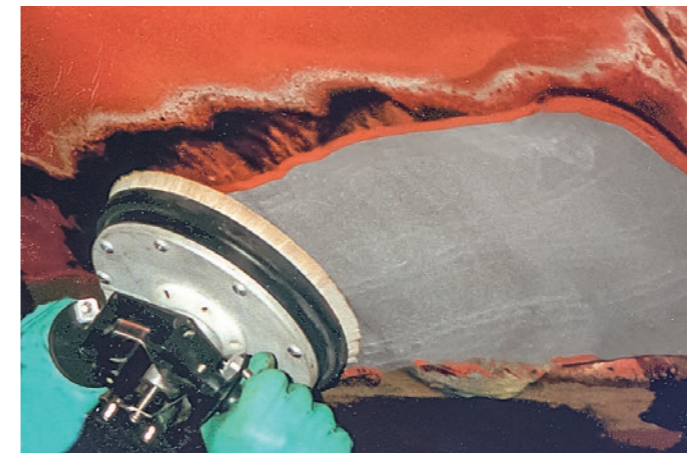

Handheld Aquablast - manual surface cleaning equipment

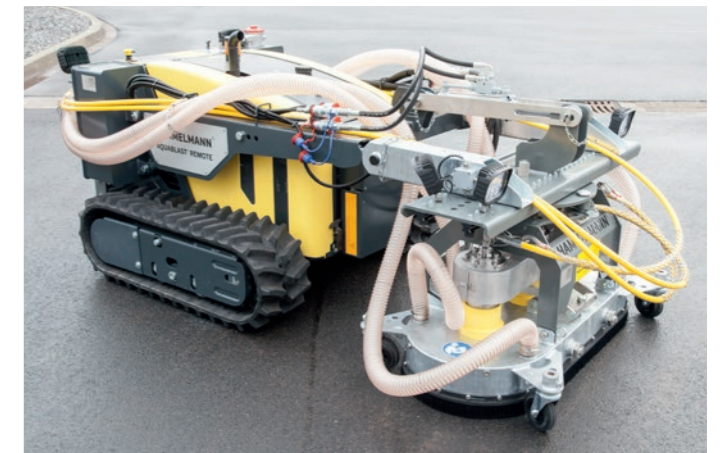

Aquablast Remote - to accept surface cleaning devices



Dockboy - surface preparation on ship hull bottoms

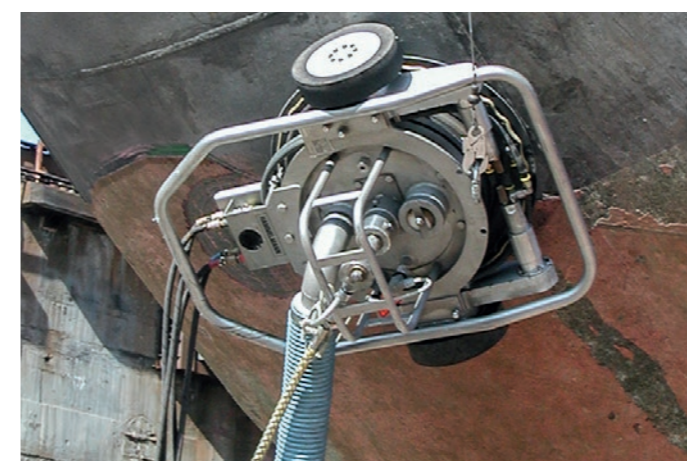

Spiderjet - vacuum adhering surface cleaning device



Abrasive cutting injectors and handling equipment

The factory - Oelde



Certification

DIN EN ISO 9001
DIN EN ISO 14001
DIN EN ISO 50001
BS OHSAS 18001
TÜV ATEX 2524 X
ASME-U
Achilles



Hammelmann service worldwide

Subsidiaries in USA, China, Australia, Brazil, Spain and 40 agents and distributors worldwide



Hammelmann GmbH
Carl-Zeiss-Straße 6-8
59302 Oelde • Germany

www.hammelmann.com
mail@hammelmann.de
Phone: +49 (0) 25 22/76 - 0



Member of
INTERPUMP GROUP

